

Thales MissionLINK™ Installation Guide

This document contains technology controlled for export by the U.S. Department of Commerce in accordance with Export Administration Regulations. Diversion contrary to U.S. law prohibited.



Export Compliance:

This product is controlled by the export laws and regulations of the United States of America. The U.S. Government may restrict the export or re-export of this product to certain individuals and/or destinations. For further information, contact the U.S. Department of Commerce, Bureau of Industry and Security.

This product User shall comply with all applicable laws related to export and import of this product in any jurisdiction and/or government authority. User shall be responsible for complying with any and all export and import restrictions, laws and regulations in any country User is conducting business.

Disclaimer:

This manual contains information that is current as of the date shown on the front cover. Every effort has been made to ensure the correctness and completeness of the material in this document. The information in this document is subject to change without notice.

Thales®, Thales MissionLINK™, and any other Thales trademark or Thales service mark referred to or displayed in this document are trademarks or registered trademarks of Thales.

Legal Notices

This product is subject to a Limited Warranty, Limitations, Exclusions, and Terms and Conditions, which can be found on line at www.thalesdsi.com.

Prior to installing this product, read and understand this Installation Guide and the User Manual, including the safety warnings and information. Failure to do so could result in serious injury or death.

Intellectual Property

User acknowledges that the Products involve valuable patent, copyright, trademark, trade secret and other proprietary rights of Thales and others. No title to or ownership of any proprietary rights related to any Product is transferred to User or any Customer pursuant to the use of this product. The purchase of any Thales products shall not be deemed to grant either directly or by implication or otherwise, any license under copyrights, patents, or patent applications of Thales or any third party software providers, except for the normal, nonexclusive, royalty free license to use that arises by operation of law in the sale of a product.

Content Copyright

User is exclusively responsible for the use of this product, including proper use of third party copyrighted materials. If the User violates these terms, the User agrees to defend, indemnify and hold Thales harmless with respect to any claims or actions by third parties related to the improper use of copyrighted material and to pay all costs, damages, fines and other amounts incurred by Thales, or on its behalf, in the defense of any such claims or actions.

Indemnity

User agrees to defend, indemnify and hold Thales harmless with respect to any claims or actions by any governmental entities or other third parties related to any violation of law with use of the Product or Accessories, misuse of the Product or Accessories under these Terms and Conditions, or any other violation of these Terms and Conditions and further agrees to pay all costs, damages, fines and other amounts incurred by Thales, or on Thales's behalf, in the defense of any such claims or actions.

SOFTWARE LICENSE

The following terms govern User's access and use of the Thales-supplied software ("Software") contained on the Product or Accessories.

License. Conditioned upon compliance with these Terms and Conditions, Thales grants to USER a nonexclusive and nontransferable license to use for USER's internal purposes the Software and the Documentation. "Documentation" means any written information pertaining to the Software and made available by Thales with the Software in any manner. USER shall use the Software solely as embedded for operation of this product.

No other licenses are granted by implication, estoppel or otherwise.

Thales Product Warranty Claim Process

Please see the Thales website at www.thalesdsi.com.

User Documentation:

Thales Defense & Security, Inc. continually evaluates its user documentation for accuracy and completeness. Any suggestions you may have for changes or additions should be sent to THALES_ILS@thalesdsi.com Subject Line: Thales MissionLINK™ Installation Guide (PN 84465/84465-IETM).

Table of Contents

CHAPTER 1 INTRODUCTION	1-1
INTRODUCTION.....	1-1
EQUIPMENT OVERVIEW	1-1
<i>Terminal Unit</i>	1-2
<i>Broadband Active Antenna (BAA)</i>	1-5
MISSIONLINK™ KIT CONTENTS.....	1-6
TOOLS AND SUPPLIES NEEDED FOR INSTALLATION	1-8
CHAPTER 2 INSTALLATION	2-1
GENERAL GUIDELINES	2-1
<i>Preparation</i>	2-1
<i>Precautions During Installation</i>	2-1
INSTALLATION	2-2
MOUNTING THE BROADBAND ACTIVE ANTENNA (BAA)	2-2
<i>Magnetic Mounting Detail</i>	2-3
<i>Hard Mounting Detail</i>	2-5
INSTALLING THE TERMINAL UNIT.....	2-7
CONNECTING POWER TO THE TERMINAL UNIT.....	2-10
<i>DC Power Connection</i>	2-11
SYSTEM STATUS INDICATORS.....	2-13
CHAPTER 3 TROUBLESHOOTING	3-1
TROUBLESHOOTING.....	3-1
CHAPTER 4 TECHNICAL SPECIFICATIONS	4-1
TECHNICAL SPECIFICATIONS	4-1
TEMPERATURE	4-2
PHYSICAL CHARACTERISTICS	4-2
CONNECTOR DETAILS.....	4-3
<i>TU 12V Connection Detail</i>	4-4
<i>TU 10-32VDC Connection Detail</i>	4-4
CHAPTER 5 ACRONYMS / GLOSSARY	5-1
ACRONYMS / GLOSSARY.....	5-1
INDEX	INDEX-1
APPENDIX A ANTENNA MOUNTING TEMPLATE (PN 3900013-1).....	A-1
APPENDIX B TERMINAL UNIT MOUNTING TEMPLATE (PN 3900011-1)	B-1

List of Figures

FIGURE 1-1 MISSIONLINK™ SYSTEM WITH CONNECTED HARDWARE	1-1
FIGURE 1-2 TERMINAL UNIT (TU).....	1-2
FIGURE 1-3 TERMINAL UNIT (TU) LEDs	1-3
FIGURE 1-4 TERMINAL UNIT (TU) FRONT PANEL DETAIL.....	1-4
FIGURE 1-5 TERMINAL UNIT (TU) BACK PANEL DETAIL	1-5
FIGURE 1-6 BROADBAND ACTIVE ANTENNA (BAA) UNIT	1-5
FIGURE 2-1 MAGNETIC MOUNT ANTENNA	2-3
FIGURE 2-2 HARD MOUNT ANTENNA.....	2-5
FIGURE 2-3 TERMINAL UNIT MOUNTING DETAIL.....	2-7
FIGURE 2-4 SIM CARD WITH COVER OPENED	2-9
FIGURE 2-5 INSTALLING SIM CARD AND ENGAGING THE LOCK	2-9
FIGURE 2-6 SECURE THE SIM CARD COVER.....	2-9
FIGURE 2-7 10V - 32V DC POWER CONNECTION	2-11
FIGURE 2-8: 24V DC POWER CONNECTION.....	2-12
FIGURE 2-9 TERMINAL UNIT (TU) LEDs	2-13
FIGURE 4-1 GPIO CONNECTOR PIN DETAIL	4-3
FIGURE 4-2 12V INPUT AND MATING CONNECTOR DETAIL	4-4
FIGURE 4-3 10-32 VDC AND MATING CONNECTOR DETAIL	4-4

List of Tables

TABLE 1-1 TERMINAL UNIT LED STATUS	1-3
TABLE 1-2 MISSIONLINK™ KIT	1-6
TABLE 1-3 AVAILABLE MISSIONLINK™ ACCESSORIES.....	1-7
TABLE 2-1 MAGNETIC MOUNT KIT COMPONENTS (PN 1100790-501).....	2-3
TABLE 2-2 INSTALLATION KIT, MOUNTING HARDWARE (LAND) (PN 1100792-501).....	2-5
TABLE 2-3 INSTALLATION KIT, TERMINAL UNIT (PN 1100789-501)	2-8
TABLE 2-4 TERMINAL UNIT LED STATUS	2-13
TABLE 3-1 TROUBLESHOOTING	3-1
TABLE 4-1 TECHNICAL SPECIFICATIONS	4-1
TABLE 4-2 OPERATING AND STORAGE TEMPERATURES	4-2
TABLE 4-3 PHYSICAL CHARACTERISTICS	4-2
TABLE 4-4 GPIO CONNECTOR PIN DEFINITION.....	4-3
TABLE 5-1 LIST OF ACRONYMS	5-1
TABLE 5-2 LIST OF DEFINITIONS	5-2

SAFETY

The MissionLINK™ system should only be installed by a qualified installer of land electronic systems. Improper installation could lead to system failure or could result in injury. The following are general safety precautions and warnings that all personnel must read and understand prior to installation, operation and maintenance of the MissionLINK™ system. Each chapter may have other specific warnings and cautions.



SHOCK HAZARD

The MissionLINK™ system is a sealed system and is not meant to be opened for repair in the field by operators or technicians. Covers must remain in place at all times on the Terminal Unit and Broadband Active Antenna to maintain the warranty terms. Make sure the system is correctly grounded and power is off when installing, configuring and connecting components.



DO NOT OPERATE IN AN EXPLOSIVE ATMOSPHERE

This equipment is not designed to be operated in explosive environments or in the presence of combustible fumes. Operating this or any electrical equipment in such an environment represents an extreme safety hazard.



LITHIUM ION BATTERIES

The Terminal Unit (TU) contains a small Li-ion battery. Li-ion batteries have a very high energy density. Exercise precaution when handling and testing. Do not short circuit, overcharge, crush, mutilate, nail penetrate, apply reverse polarity, expose to high temperature or disassemble. High case temperature resulting from abuse of the cell could cause physical injury.



ANTENNA RADIATION HAZARDS

To comply with FCC Radio Frequency radiation exposure limits, the antenna must be installed at a minimum safe distance as shown below.

During operation, the antenna radiates high power at microwave frequencies that can be harmful to individuals. While the unit is operating, personnel should maintain a minimum safe distance of **1.0 meter (3.3 ft.)** from the antenna. The antenna should be mounted in an area that prevent the possibility of close exposure to the antenna's radiation.

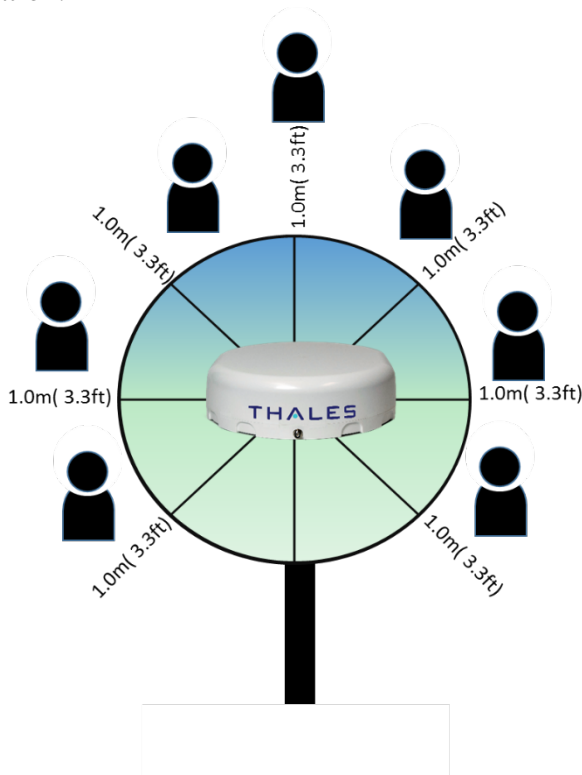

FCC INFORMATION



NOTE

FCC Identifier: OKCMF350BV
Contains FCC ID: QQQWF121

Changes or modifications not expressly approved by the manufacturer could void the user's authority to operate the equipment.

Note:

This equipment has been tested and found to comply with the limits for a [Class B digital device](#), pursuant to part 15 of the FCC Rules. These limits are designed to provide reasonable protection against [harmful interference](#) in a residential installation. This equipment generates, uses and can radiate [radio frequency energy](#) and, if not installed and used in accordance with the instructions, may cause [harmful interference](#) to radio communications. However, there is no guarantee that interference will not occur in a particular installation. If this equipment does cause [harmful interference](#) to radio or television reception, which can be determined by turning the equipment off and on, the user is encouraged to try to correct the interference by one or more of the following measures:

- Reorient or relocate the receiving antenna.
- Increase the separation between the equipment and receiver.
- Connect the equipment to a source on a circuit different from that to which the receiver is connected.
- Consult the dealer or an experienced radio/TV technician for help.

Industry Canada Information



NOTE

Industry Canada: 473C-MF350BV
Contains IC: 5123A-BGTWF121

Under Industry Canada regulations, this radio transmitter may only operate using an antenna of a type and maximum (or lesser) gain approved for the transmitter by Industry Canada. To reduce potential radio interference to other users, the antenna type and its gain should be so chosen that the equivalent isotropically radiated power (e.i.r.p.) is not more than that necessary for successful communication.

Conformément à la réglementation d'Industrie Canada, le présent émetteur radio peut fonctionner avec une antenne d'un type et d'un gain maximal (ou inférieur) approuvé pour l'émetteur par Industrie Canada. Dans le but de réduire les risques de brouillage radioélectrique à l'intention des autres utilisateurs, il faut choisir le type d'antenne et son gain de sorte que la puissance isotrope rayonnée équivalente (p.i.r.e.) ne dépasse pas l'intensité nécessaire à l'établissement d'une communication satisfaisante.

This radio transmitter (473C-MF350BV) has been approved by Industry Canada to operate with the antenna listed in Table 4-1 with the maximum permissible gain and required antenna impedance for each antenna type indicated. Antenna types not included in this list, having a gain greater than the maximum gain indicated for that type, are strictly prohibited for use with this device.

Le présent émetteur radio (473C-VF350BM) a été approuvé par Industrie Canada pour fonctionner avec les types d'antenne énumérés ci-dessous et ayant un gain admissible maximal et l'impédance requise pour chaque type d'antenne. Les types d'antenne non inclus dans cette liste, ou dont le gain est supérieur au gain maximal indiqué, sont strictement interdits pour l'exploitation de l'émetteur

This device complies with Industry Canada license-exempt RSS standard(s). Operation is subject to the following two conditions: (1) this device may not cause interference, and (2) this device must accept any interference, including interference that may cause undesired operation of the device.

Le présent appareil est conforme aux CNR d'Industrie Canada applicables aux appareils radio exempts de licence. L'exploitation est autorisée aux deux conditions suivantes : (1) l'appareil ne doit pas produire de brouillage, et (2) l'utilisateur de l'appareil doit accepter tout brouillage radioélectrique subi, même si le brouillage est susceptible d'en compromettre le fonctionnement.

Thales Defense & Security, Inc.

Declaration of Conformity with Radio Equipment Directive

The undersigned of this letter declares that the following equipment complies with the specifications of Radio Equipment Directive (2014/53/EU) concerning Radio & Telecommunications Equipment.

Equipment included in this declaration

VF350BM VesseLINK Broadband Maritime Certus Satellite Terminal and Antenna

MF350BV MissionLINK Broadband Maritime Certus Satellite Terminal and Antenna

Equipment Applicability

The VesseLINK and MissionLINK provide voice and high speed data communication over 100% of the globe through the Iridium Certus broadband Satellite system.

Declaration

The health requirement is met by conforming to EU standard EN 62311. The safety requirement is met by conforming to EN 60950-1:2006 w/A2:2013. The electromagnetic compatibility as set out in Directive 2014/30/EU is met by conforming to the EU standards ETSI EN 301-489-1 and ETSI EN 301-489-17. Effective and efficient use of radio spectrum in order to avoid harmful interference is met by conforming to the ETSI EN 301-441 standard.

Manufacturer

Thales Defense & Security, Inc. 22605 Gateway Center Drive
Clarksburg, Maryland 20871 U.S.A.

Place and Date

Clarksburg, MD, 15 August 2018

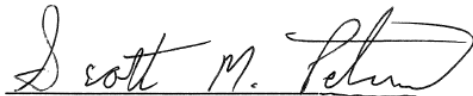

Scott Peters

Director, Product Management

CHAPTER 1 INTRODUCTION

INTRODUCTION

This installation guide provides instructions for proper installation and initial start-up of the MissionLINK™ system and a basic system overview. It contains critical information and safety guidelines for those who install the system and perform initial system activation and test.

After initial start-up, for more detailed operational procedures, refer to the MissionLINK™ User Manual (Document # 84468) located on the Thales website and is also accessible through the terminal's Management Portal.

This MissionLINK™ system contains the Terminal Unit, the Broadband Active Antenna (BAA) with magnetic mounts, a 20 ft DC power cord, a Wi-Fi antenna, mounting hardware, and a 10 ft RF cable. Additional accessories are available. (Refer to Table 1-2 and Table 1-3 for a complete list of available items).

EQUIPMENT OVERVIEW

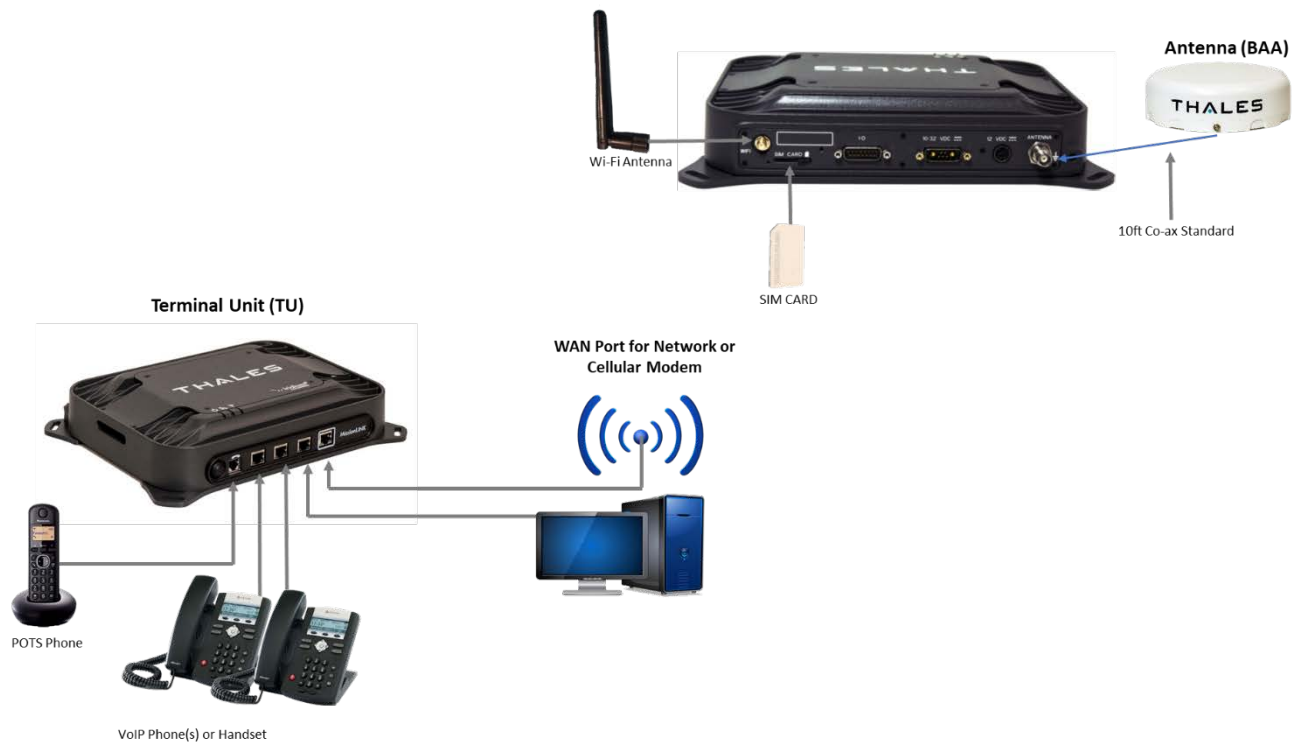

Figure 1-1 MissionLINK™ System with Connected Hardware

Terminal Unit

The Terminal Unit (TU) supports voice and data communications in a land mobile or terrestrial fixed environment. The TU is capable of supporting wireless voice and data that links the user with the Iridium satellite network. The TU, depending on Line of Site (LOS) and Low Earth Orbiting (LEO) Satellites, will be able to maintain satellite connectivity while experiencing conditions varying from urban canyons to high vibration from road movement. As a wireless access point, the TU provides Wi-Fi (802.11) access for data and Voice over IP (VoIP) calls. Three RJ-45 Ethernet connectors and one RJ14 jack enables the user to tether directly to the TU, if desired. The Management Portal is a graphical user interface that can be used to modify system settings and indicate system status. The TU is powered by an included DC power cable with a 10-32V input range and remote start wire, accommodating all types of vehicles and battery types. It also can be powered by an optional 12 Volt AC to DC power source for fixed applications where AC power or a DC power inverter is available.



Figure 1-2 Terminal Unit (TU)

The Terminal Unit has three status LEDs on the top of the unit that indicate status of system power-up, satellite connection and the Wi-Fi.

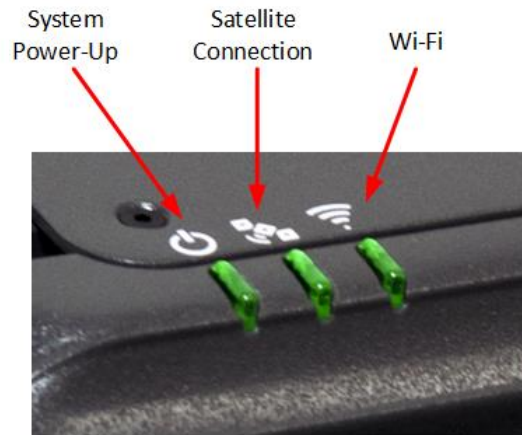

Figure 1-3 Terminal Unit (TU) LEDs

Table 1-1 Terminal Unit LED Status

Indicator	Description
System	
Solid GREEN	System functioning properly
Flashing GREEN	System busy (Booting up)
Solid RED	Fault (minor issue)
Flashing RED	Critical fault (major issue)
Satellite	
Solid BLUE	Connected and passing data (over satellite)
Solid GREEN	System functioning properly
Flashing GREEN	Acquiring satellite
Solid RED	Fault (minor issue)
Flashing RED	Critical fault (major issue)
Wi-Fi	
OFF	Wi-Fi OFF
Flashing GREEN	Wi-Fi busy
Solid Green	System functioning properly
Solid RED	Fault (minor issue)
Flashing RED	Critical fault (major issue)



NOTE

The Indicator Colors are:

Solid Green: Operational

Flashing Green: Start-up or in progress of configuring or acquiring service.

Solid Red: fault requires user attention (Open Management Portal for Alerts)

Flashing Red: critical fault requiring immediate attention. For additional information, refer to CHAPTER 3 TROUBLESHOOTING

The Terminal Unit front panel (left to right) has a main power button, one RJ-14 jack for POTS (Plain Old Telephone Service) Phone(s), three PoE (Power over Ethernet) RJ-45 connections for VoIP phones or Ethernet-based devices, and one WAN (Wide Area Network) connection primarily used to connect an external cellular modem or VSAT.

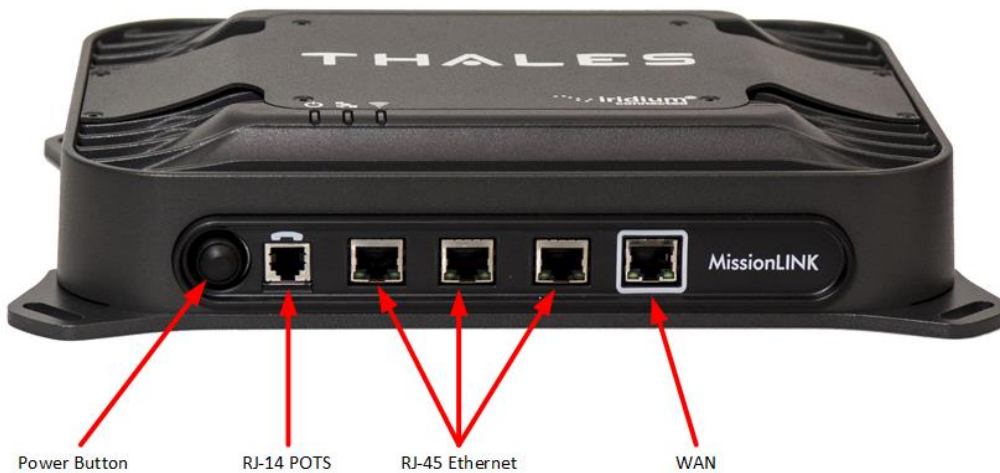

Figure 1-4 Terminal Unit (TU) Front Panel Detail

The Terminal Unit back panel (left to right) has a Wi-Fi antenna connector, reset button, SIM Card slot, GPIO (I/O) connector, 10-32 Volt DC input connector, 12 Volt DC power input, antenna connector, and chassis grounding lug.

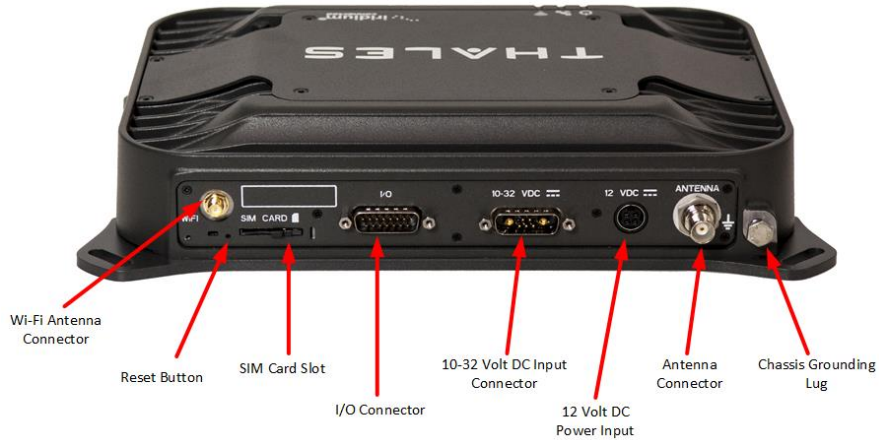

Figure 1-5 Terminal Unit (TU) Back Panel Detail

Broadband Active Antenna (BAA)

The BAA is a separate unit that is required to connect to the Terminal Unit through a single coaxial cable. DC power, RF transmit and receive signals, control data and GPS data are communicated between the BAA and Terminal Unit through the single coaxial cable. Connect provided cable to the antenna after installing the antenna and before connecting it to the Terminal Unit. The connector is shown in Chapter 2.



Figure 1-6 Broadband Active Antenna (BAA) Unit

MISSIONLINK™ KIT CONTENTS

Table 1-2 MissionLINK™ Kit

IRIDIUM System Part Number		Description	
MF350BV		Kit, MissionLINK™ Vehicular High Gain 350**	
Qty	Part Number	Description	
✓	1	1100789-501	Kit, Terminal Unit, Mounting Hardware
✓	1	1100790-501	Kit, Antenna Magnetic Mount
✓	1	1100792-501	Kit, Antenna Mounting Hardware Land
✓	1	1600899-1	Broadband Active Antenna (BAA)
✓	1	3402174-1	Quick Start Guide (QSG) MissionLINK™
✓	1	3900011-1	Mounting Template, Terminal Unit
✓	1	3900013-1	Mounting Template, BAA
✓	1	4102947-502	Terminal Unit 350, IRIDIUM CERTUS Land
✓	1	855021-010	RF Cable, 10 ft LMR240
✓	1	855024-020	Cable, Vehicle DC Power Harness 20 ft
✓	1	855026-010	Cable, RJ-45 Ethernet, 10 ft
✓	1	85728-001	Wi-Fi Antenna, 2.4 GHz Dipole 2 dBi

** The MF350BV is capable of up to 350 kbps uplink and downlink speeds.

Note: The SIM card is provided by the airtime service provider and may be packaged separately from this kit.

Table 1-3 Available MissionLINK™ Accessories

Description	Part Number	Qty
Thales SureLINK IP Handset Kit	1100818-501	1
Power Supply, AC/DC 12V – 160W	84670-001	1
Cable AC Power with USA Plug Type B IEC 60320-C13 Connect Blk 6 ft	854024-001	1
Cable AC Power with Euro Plug Type E IEC 320-C14 Connect Blk 6 ft	854025-001	1
Cable AC Power with AUS Plug Type 1 IEC 320-C14 Connect Blk 6 ft	854026-001	1
Cable AC Power with UK Plug Type G IEC 320-C13 Connect Blk 6 ft	854027-001	1
RF Cable: 10 ft LMR240 Cable TNCM-TNCM Coax TWS (LMR) 240 Mat 10Ft	855021-010	1
RF Cable: 20 ft, LMR240	855021-020	1
RF Cable: 30 ft LMR240RF Cable TNCM-TNCM COAX TWS (LMR) 240 MAT 30FT	855021-030	1
RF Cable 50 ft LMR240	855021-050	1
RF Cable 100 ft TNCM-TNCM COAX TWS (LMR) 400 MAT 100FT (Fixed Locations)	855022-100	1
Cable, Vehicle DC Power Harness 20 ft Cable, Vehicle Power Harness 20Ft	855024-020	1
Cable, RJ-45 Ethernet, 10 ft Cable Cat-5e Patch RJ45M-RJ-45M Blue 10ft	855026-010	1
Wi-Fi Antenna, 2.4 GHz Dipole 2 dBi Antenna 2.4 GHz Dipole 2dBi Rev Pol SMA 50 OHM	85728-001	1

TOOLS AND SUPPLIES NEEDED FOR INSTALLATION

List of tools you may need to install this system:

- Drill and drill bits
- Pliers or wrench
- 4mm Hex Drive Wrench
- Torque Wrench
- Allen Head Kit – Insert Bit Kit Z-MC7
- Marker or pencil
- Tie wraps
- Self-vulcanizing tape to seal connections

CHAPTER 2 INSTALLATION

GENERAL GUIDELINES

General Guidelines for Installation

- Do not attempt to service items such as Terminal Unit and Antenna.
- Always use Ground Lugs as separate connections to chassis.
- Always torque hardware to specified values.
- Always keep the MissionLINK™ antenna away from other radiating antennas that may interfere with it.

Preparation

Prepare the MissionLINK™ Installation Kit as follows:

1. Unpack and lay out all components and parts.
2. Inspect for any damage
3. Conduct an inventory of all components and parts using the equipment packing list provided with the equipment. Any missing items and/or shipping damage should be reported immediately to Thales Customer Service Department (Tel: (800) 324-6089 or email customer.service@thalesdsi.com).

Precautions During Installation

The following steps should be followed to prevent damage to the equipment:

1. Keep dust cover over the SIM Card, once installed.
2. Do not disassemble or modify parts in installation kit unless instructed to do so.
3. Keep mounting hardware covered and protected until needed.

INSTALLATION

The following information covers the installation and set-up of the MissionLINK™ Broadband Active Antenna (BAA) and Terminal Unit (TU).

To complete the installation, you need the appropriate fasteners, tools, and mounts.



NOTE

Always wear safety goggles, ear protection, and a dust mask when drilling, cutting, or sanding. When drilling or cutting, always check first to see what is on the other side of surface. If you experience difficulty with the installation, contact Thales or seek the assistance of a professional installer.

Installation will be accomplished with the following installation hardware kits:

- Antenna (2 options)
 - Magnetic Mounting: Mounting Hardware Kit PN 1100790-501
 - Hard Mount: Mounting Hardware Kit PN 1100792-501
- Terminal Unit: Mounting Hardware Kit PN 1100789-501

MOUNTING THE BROADBAND ACTIVE ANTENNA (BAA)

There are two (2) mounting options for the Antenna, each of these are described below:

- Magnetic Mounting, and
- Hard Mount.

It is important to note that the coaxial cable provided in the MissionLINK™ kit, or one of the Thales approved accessory coaxial cables, must be installed for proper operation of the MissionLINK™ system. Otherwise, the system may not calibrate correctly and will result in a failure at start-up. Install the cable using best practices for cable bend radius and to avoid pinching the cable. It is also important to ensure the cable does not get cut by or rub on nearby sharp objects. If longer cables are needed, refer to Table 1-3).

Keys to successful installation of the MissionLINK™ Antenna:

- Mount where antenna is at least the minimum safety distance away from personnel (1.0m).
- Mount antenna with unobstructed (Full View) of the sky. Any blockage to part of the sky by metal objects could result in loss of connection and/or poor data speeds.
- Mount the antenna level on a flat surface.
- Make sure magnetic mounts are secure and tight on the antenna prior to installation.
- Keep antenna away from large metallic objects in the field of view when possible to increase performance. Metal surfaces below the antenna are fine (example: the vehicle's roof.)
- Mount as far away from other antennas (HF, VHF, and UHF antennas) as possible to avoid interference.

- Use the supplied RF cable designed for MissionLINK™. Do not alter the provided cable prior to installation. It is recommended to weather seal the connection at the antenna on permanent installations to prevent corrosion.
- Mounting should be in an area that minimizes vehicle vibration

Magnetic Mounting Detail

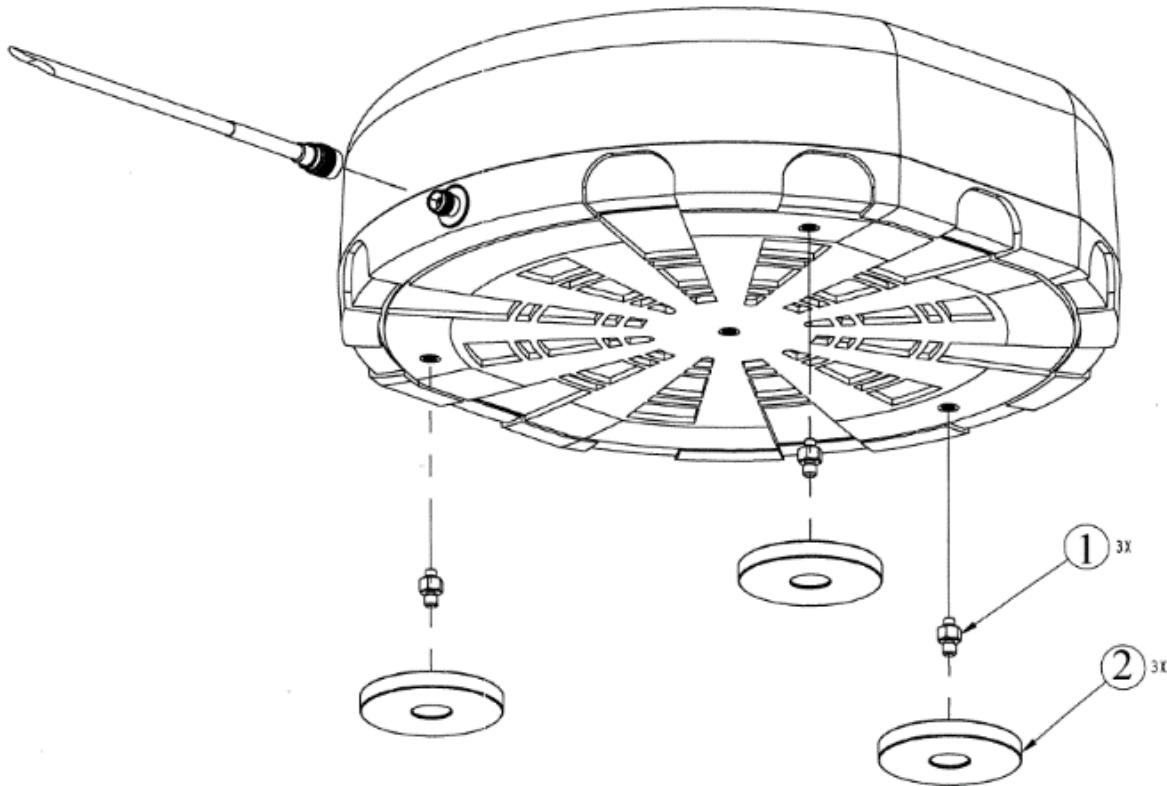

Figure 2-1 Magnetic Mount Antenna

Table 2-1 Magnetic Mount Kit Components (PN 1100790-501)

Item Number	Description	Part Number	Qty
1	Standoff, Adapter Male-Male	2401953-1	3
2	Magnetic Encased 5/16" THK 32lb Pull MNT-Hole M5 Rubber BLK	599000-001	3

1. Assemble Items No. 1 (3x) and 2 (3x) (included with Antenna Mounting Hardware Kit PN 1100790-501) to antenna at the three perimeter mounting points as shown in Figure 2-2 and hand tighten.



Do Not tool tighten or torque the mounts. Doing so could cause damage to the unit.

NOTE

2. Place Antenna in desired final operating location on ferrous surface with all three magnets in contact with surface. Failure to make contact with all three magnets may cause loss of mount integrity.
3. Connect coaxial cable as shown in Figure 2-1 and hand tighten.
4. Run coaxial cable, Figure 2-1, to approximate location of the Terminal Unit installation location.



IMPORTANT: Antenna cable connection should be secured tightly and covered with protective rubber boot or self-vulcanizing tape (not included) to prevent corrosion.

NOTE



IMPORTANT: When removing the antenna with magnetic mounts from a metal surface, do not pull up on the coaxial cable or connector. This could damage the antenna.

NOTE

Hard Mounting Detail

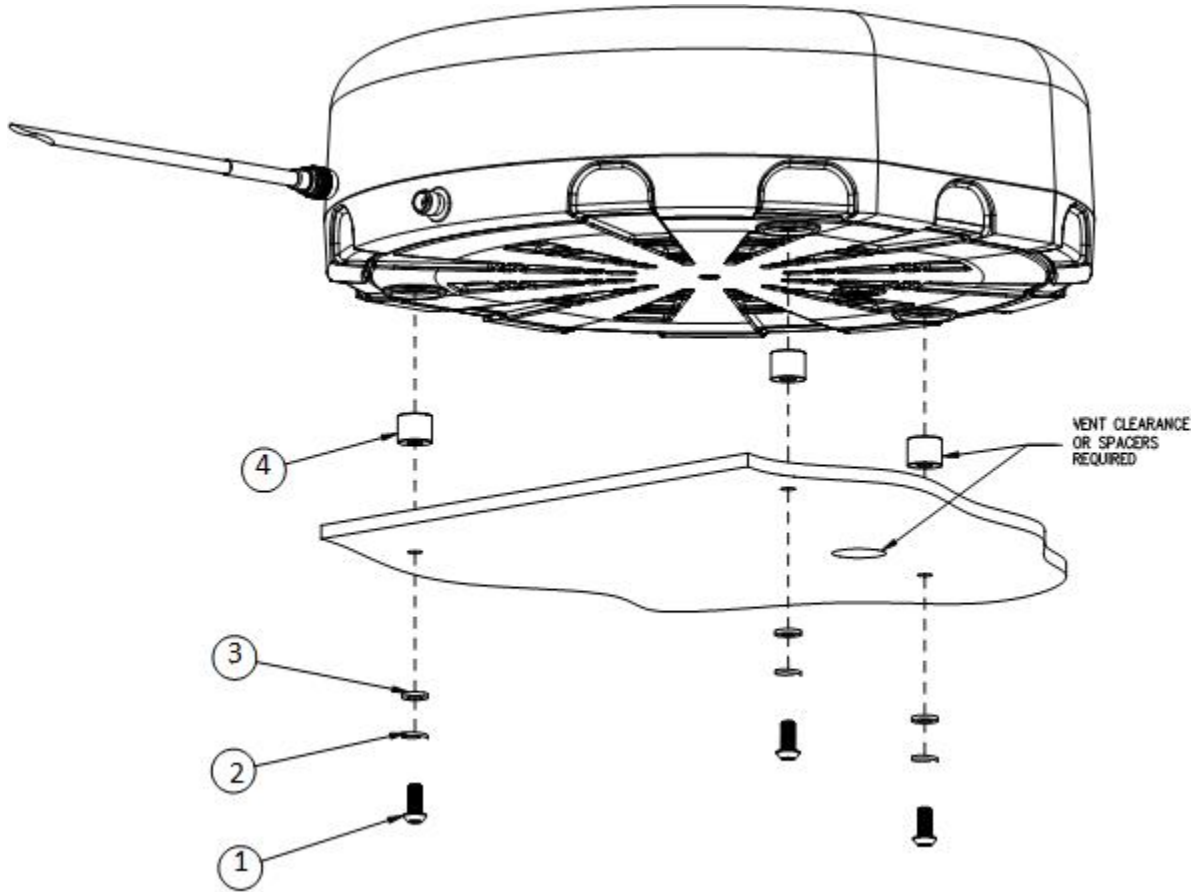

Figure 2-2 Hard Mount Antenna

Table 2-2 Installation Kit, Mounting Hardware (Land) (PN 1100792-501)

Item Number	Description	Part Number	Qty
1	Screw, Button HD Socket Cap M6x1x12mm A4-70 (ISO 7380) SS	82769-001	3
	Screw, Button HD Socket Cap M6x1x14mm A4-70 (ISO 7380) SS	82769-002	3
	Screw, Socket Cap Button HD TFL M6x1x25mm	82780-025-RC	3
	Screw, Socket Cap Button HD TFL M6x1x30mm	82780-030-RC	3
2	Washer, Split M6 (DIN 127B) A4 L/W SS	71300-001	3
3	Washer, Flat M6 A4-80 (DIN 125 ISO 7089) SS	71299-001	3
4	Spacer, Round 1/2"L x 5/8"W	8294-001-RC	3
NI	Self-Vulcanizing Tape	91384-001	1



NOTE

Mounting Hardware Installation Kit (PN 1100792-501) contains additional hardware spares. The quantity listed in the above table reflect what is required for installation.



NOTE

Mounting screws (1, Figure 2-2) listed in four lengths to accommodate mounting plate thickness of .12 to .24 inches.



NOTE

Mounting surface in contact with the antenna must be flat. If flat, verify that the vent clearance hole is implemented or spacers are installed (4, Figure 2-2).



NOTE

The Antenna Mounting Template is provided in Appendix A for use in fabricating a custom plate. A mounting plate is not included in the kit.

1. Use the template information provided in Appendix A to create the appropriate hole pattern in the desired mounting surface for the chosen mounting hardware.



NOTE

Hole sizing and provided hardware are shown for through hole mounting as shown in Appendix A. User may mount antenna with other hardware at their discretion and own risk.

2. Position the pattern to avoid interferences with the antenna or coaxial cable connection to the antenna.
3. Position the antenna in the proper orientation as decided by the pattern placement for the chosen mounting pattern on the base of the antenna (Refer to Appendix A).



NOTE

IMPORTANT: The antenna is mounted with either three M6 torque to 6 Nm (4.5 ft-lbs.) stainless steel bolts (included with Antenna Mounting Hardware Kit PN 1100792-501) as appropriate for mounting plate thickness of .12 to .24 inches (3 to 6 mm.). **Never exceed the recommended torque values on mounting bolts as this will damage the unit.**

4. If spacers are required for proper spacing for the vent (4, Figure 2-2) assemble spacers as shown in Figure 2-2.
5. Assemble screws (1) with flat washers (3) and split lock washers (2) as shown in Figure 2-2 and torque to requirements.

6. Connect coaxial cable as shown in Figure 2-2 and hand tighten.
7. After connecting the cable to the antenna (Figure 2-2), wrap the connector with the self-vulcanizing tape to ensure a water-tight seal.
8. Run coaxial cable to approximate location of the Terminal Unit installation location.

INSTALLING THE TERMINAL UNIT

The MissionLINK™ Terminal Unit is designed for ease of installation with four corner mounting locations for direct mounting.



NOTE

It is recommended that the Terminal Unit be mounted in a cool dry place leaving sufficient room (3 in. or 8 cm) between the Terminal Unit and other equipment to allow for proper airflow.

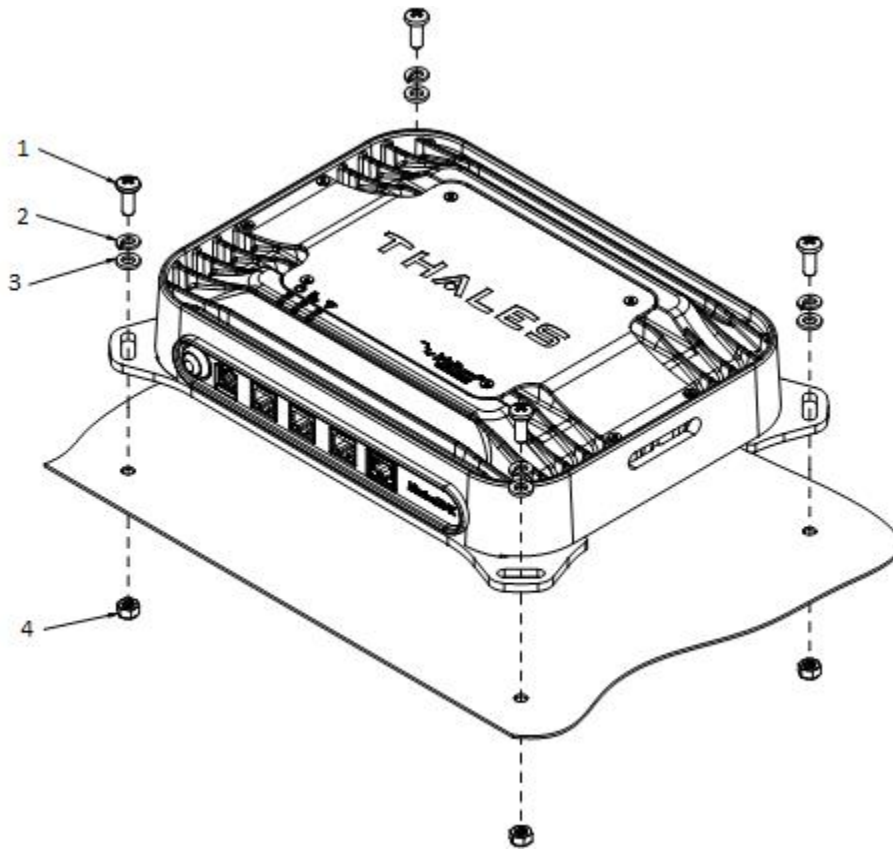

Figure 2-3 Terminal Unit Mounting Detail

Table 2-3 Installation Kit, Terminal Unit (PN 1100789-501)

Item Number	Description	Part Number	Qty
1	Screw Phil Pan HD 18-8 M6x1x16mm SS BLK Oxide	82767-001	4
	Screw Phil Pan HD 18-8 M6x1x20mm SS BLK Oxide	82768-001	4
2	Washer Split Lock M6 (DIN 127B) A4 SS BLK Oxide	71304-001	4
3	Washer Flat M6 6.4mm ID x 12mm OD x 1.6mm THK SS BLK Oxide	71298-001	4
4	Nut Lock w/Nylon Insert M6x1 18-8 SS	75656-001	4

1. Use the template information provided in Appendix B to create the appropriate hole pattern in the desired mounting surface for the chosen mounting hardware.



NOTE

Hole sizing and provided hardware are shown for through hole mounting as shown in Appendix B. User may mount antenna with other hardware at their discretion and own risk.



NOTE

Terminal Unit can be mounted in any orientation but for best performance, it is recommended that it is mounted horizontally with the Thales logo facing up. This will give the best protection against any spills or dripping water and allows for the best heat transfer.

2. Position the pattern to avoid interferences with the antenna or coaxial cable connection to the antenna.
3. Assemble screws with split lock and flat washers as shown in Figure 2-3 and torque to 4.5 Ft. Lbs. (6 Nm).
4. Connect the provided Wi-Fi antenna, and install the SIM Card (from service provider) into slot.
 - a. Open the SIM Card protective cover by pulling it away from the TU, exposing the SIM card slot. (Figure 2-4).



Figure 2-4 SIM Card with Cover Opened

- b. Install SIM card from Air-time provider (1, Figure 2-5), by inserting the card with contacts down (2) until it clicks into place (3).
- c. Be sure to engage the lock for the SIM Card (4).



Figure 2-5 Installing SIM Card and Engaging the Lock

- d. Secure the SIM Card cover once the SIM Card has been locked into place to prevent moisture or dust intrusion. (Figure 2-6)



Figure 2-6 Secure the SIM Card Cover

5. Connect the provided RF cable that goes to the antenna.



NOTE

The Terminal Unit should be grounded. Use a 14 AWG (or larger) ground wire to connect the TU to earth ground during normal use.

CONNECTING POWER TO THE TERMINAL UNIT

The Terminal Unit has two power connections available:

- 20 ft. DC cable for vehicles operating from 10-32 Volts battery power (included):
 - RED + (10-32VDC)
 - BLACK – (GND)
 - Yellow (Ignition Switch)
 - Turns Terminal Unit on/off with vehicle ignition or from a remote switch
 - Leave unconnected for Terminal Unit front panel switch operation on/off
- AC Operation for fixed installations: Optional available external AC/DC supply (#84670-001) with AC power cord. AC cords are available for US, EU, UK Type G and AUS Type I.



NOTE

To safely disconnect the TU from the power source, unplug the unit from the power outlet.



NOTE

When installing the TU, the power outlet should be installed near the TU and be easily accessible.

DC Power Connection

Installations using the DC power cable should use the red and black primary power wires as well as the yellow ignition wire as the ON/OFF switching source. The Terminal Unit will turn OFF with the vehicle's ignition switch when the yellow ignition line is connected, so it is important to make that connection in the vehicle (see Figure 2-7).

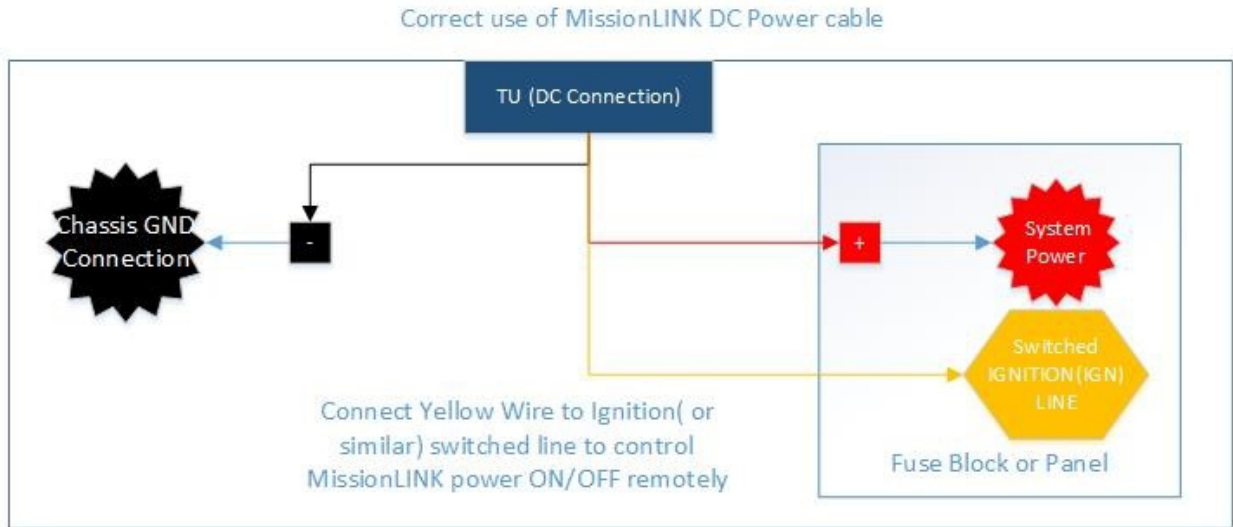

Figure 2-7 10V - 32V DC Power Connection

1. Connect the RED (+) cable to the positive terminal of DC power source.
2. Connect the BLACK (-) cable to the negative terminal of DC power source.



NOTE

Extra care and consideration must be taken when powering any device from a dual battery 24V DC system. It is important that 24V systems use the correct GND scheme that ensures unit is connected to the system's lowest potential (usually chassis GND). Otherwise damage to the Terminal Unit and antenna are likely and could void the warranty. (See Figure 2-8)

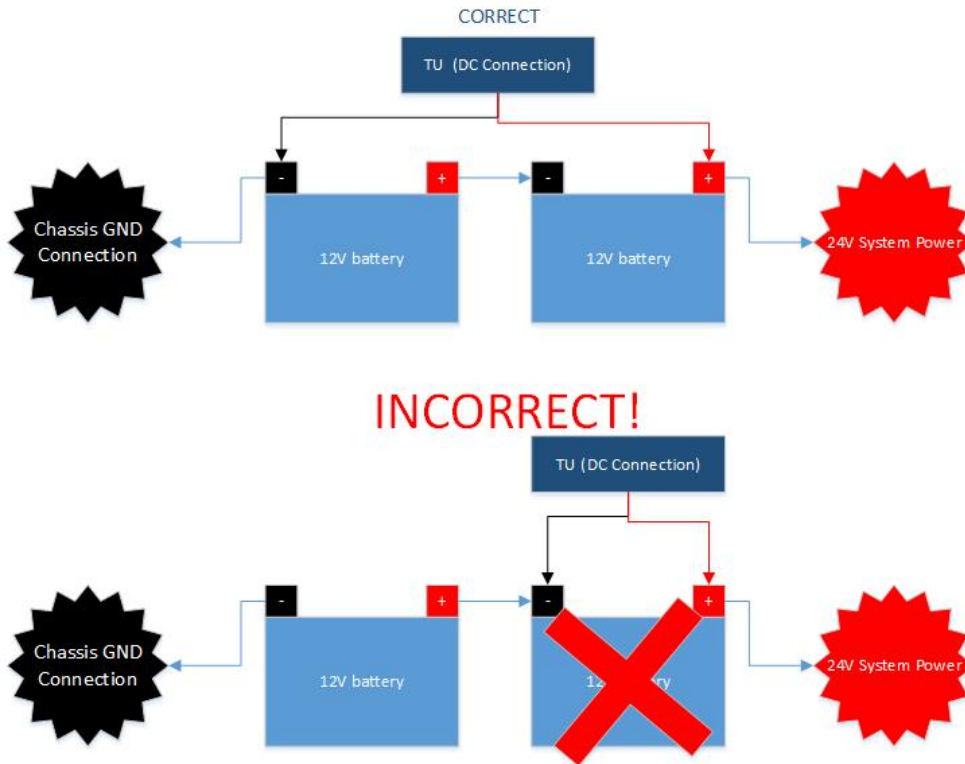

Figure 2-8: 24V DC Power Connection

3. Connect the YELLOW wire to the ignition (or similar) via the fuse box or panel.

SYSTEM STATUS INDICATORS

Now that the system installation is complete, press the start button on the TU.
 In Figure 2-8, from Left to Right these are: System (Overall System Status), Satellite (Satellite Connection Status) and Wi-Fi (Wireless Network Status).

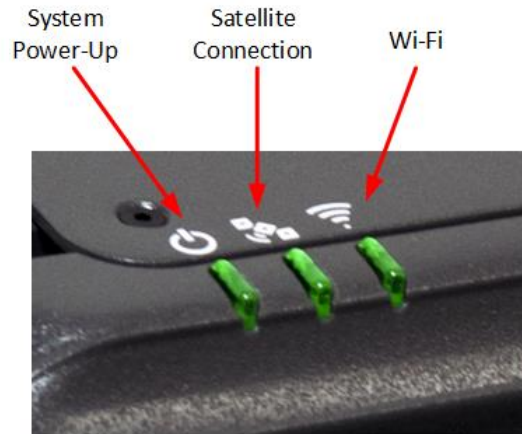





Figure 2-9 Terminal Unit (TU) LEDs

Table 2-4 Terminal Unit LED Status

Indicator	Description
 System	
Solid GREEN	System functioning properly
Flashing GREEN	System busy (Booting up)
Solid RED	Fault (minor issue)
Flashing RED	Critical fault (major issue)
 Satellite	
Solid BLUE	Connected and passing data (over satellite)
Solid GREEN	System functioning properly
Flashing GREEN	Acquiring satellite
Solid RED	Fault (minor issue)
Flashing RED	Critical fault (major issue)
 Wi-Fi	
OFF	Wi-Fi OFF
Flashing GREEN	Wi-Fi busy
Solid Green	System functioning properly
Solid RED	Fault (minor issue)
Flashing RED	Critical fault (major issue)



NOTE

The Indicator Colors are:

Solid Green: Operational

Flashing Green: start-up or in progress of configuring or acquiring service.





Solid Red: fault requires user attention (Open Management Portal for Alerts)

Flashing Red: critical fault requiring immediate attention. For additional information, refer to Chapter 3 Troubleshooting

CHAPTER 3 TROUBLESHOOTING

TRoubleshooting

Table 3-1 Troubleshooting

PROBLEM	SOLUTION
 Satellite LED Flashing Green	<ul style="list-style-type: none"> Flashing GREEN light indicates that it is acquiring the satellite. If it continues to flash for more than 5 minutes, check that the antenna has a clear view of the sky. Reboot TU.
 Satellite LED Flashing RED	<ul style="list-style-type: none"> Critical Fault Detected. Open Management Portal http://portal.thaleslink and check Alerts. Make any adjustments. (For example: check antenna connection, or GPS not acquired.) Turn unit off and on again. If same result, contact your service provider.
 System LED Flashing Green	<ul style="list-style-type: none"> Start-up in progress. Wait until unit has run diagnostics and completed start procedure. This may take more time than usual when acquiring satellites for the first time Switch power off and back on if the light doesn't turn solid green after 5 minutes.
 System LED Flashing RED	<p>Fault Detected. Open Management Portal http://portal.thaleslink and check for alerts. Make any adjustments. (For example: Common alerts include, but not limited to, are the SIM Card not installed, SIM Card not provisioned. Power-Up Test (POST) failure.)</p> <ul style="list-style-type: none"> Turn unit off and on again. If same result, contact your service provider.
 Wi-Fi LED	<p>OFF – Turn Wi-Fi ON using the Management Portal through a hardwired, PoE connection. ThalesLINK > Settings > Wi-Fi</p> <p>Solid RED – Wi-Fi may need to turned off and back on again from the Management Portal. If the LED does not turn to GREEN within a minute, reboot the TU.</p> <p>Flashing GREEN – If this continues for more than a minute or two, check for NO OR WEAK Wi-Fi</p>

PROBLEM	SOLUTION
No or Weak WI-FI Signal	<ul style="list-style-type: none"> • Connect Wi-Fi antenna and ensure it is secured tightly • If walls or metal obstructions are between the TU and the Wi-Fi device, move closer to the TU or move the TU to a better location with less obstructions • Check to make sure Wi-Fi device is connected to the TU's Wi-Fi and verify that you are connected to the ThalesLINK. • Check the Management Portal to make sure the Wi-Fi device is registered as a user.
Cannot connect to Wi-Fi service	<ul style="list-style-type: none"> • Check that the Wi-Fi antenna is attached and tightly screwed in. • Check that the TU's Wi-Fi LED is solid GREEN. • Check to see if there's an available connection by checking the devices that are connected in Status → Current Devices page. • Only 5 simultaneous devices can connect to the Wi-Fi. Any additional connection attempts are blocked. • Remove one or more devices from the Wi-Fi and try again to connect. • Use the Wi-Fi Device Whitelist to limit access to specific wireless devices.
Cannot connect to the Management Portal	<ul style="list-style-type: none"> • Ensure Terminal Unit is powered ON • Ensure Wi-Fi is enabled and connected to ThalesLINK (or renamed SSID). If using a Wi-Fi enabled device, the Wi-Fi LED on the TU should be solid GREEN. If not using Wi-Fi, ensure Cat 5 cable is connected to one of the three Ethernet ports (NOT WAN or POTS Port). If Ethernet connection, replace the cable and re-check connection • Open web browser and type http://portal.thaleslink/#. Ensure network settings are correct on the connected device. • Device's browser may be incompatible. Update or try different browser. • You may need to reconnect via Ethernet or Wi-Fi to the TU. • Check to make sure the correct address is typed in http://portal.thaleslink

PROBLEM	SOLUTION
<p>ThalesLINK is not obtaining a satellite signal (Satellite LED is red)</p>	<ul style="list-style-type: none"> • Check signal bars at the top of the Management Portal. If no bars are highlighted, the satellite is not being detected. Wait a few minutes to see if the signal strength improves as another satellite comes into view. • Check antenna connection at the TU and antenna. Make sure no corrosion has occurred on the cable connections to the antenna and that the connectors are screwed in tightly. • Check antenna for a clear view of the sky with no obstructions. Relocate antenna if needed. • Check for interferers in the area that could be affecting the signal such as active radars, VSAT systems and other radio antennas. Turn those off and retest. • Move vehicle to a new location and retest if other interfering vehicles are in the area • Reboot TU and check the Alerts. • Call Service Provider if the satellite connection is still not working.
<p>Terminal Unit does not Power-ON</p>	<ul style="list-style-type: none"> • Check TU for Green lights, If green light is on Unit has Power • Push power button on front of TU. • Check that the power source is providing 10-32V and is not current limited. • Check connection of the 10-32V DC cable has correct polarity. • Check to ensure Ignition line is connected to switched line or connected to Red (Positive line) for continuous operation. • Check that ignition or remote switch is turned on if ignition line is connected. • If using AC/DC converter (optional), make sure the AC outlet has power and that the plug is securely in the AC outlet and the other end is securely connected to the TU.
<p>Terminal Unit has power but accessories not working</p>	<ul style="list-style-type: none"> • Remove power from accessories and disconnect from TU. Restart TU using the power button or remove power from TU for 10 seconds. After TU has rebooted re-attach accessories. • If PoE accessory not receiving power, make sure PoE is enabled for that port. • PoE is not available on WAN port. Any device on WAN port needs its own power source. • Check VoIP phone manuals for proper configuration. Each phone may have a different configuration method.

THIS PAGE INTENTIONALLY LEFT BLANK

CHAPTER 4 TECHNICAL SPECIFICATIONS

TECHNICAL SPECIFICATIONS

Table 4-1 Technical Specifications

Description		Parameters
Technical		
Frequency of Operation	Uplink (TX)	1616 to 1626.5 MHz
	Downlink (RX)	1616 to 1626.5 MHz
Channelization	FDMA spacing	41.667 KHz
	TDMA Timing	8.3 mS Slot in a 90 mS window
	Channels Available	240 channels
EIRP (Weighted Average)	Voice	9 dBW
	Data (Block 1)	11.7 dBW
	Data Certus™ 1xC8 16 APSK	15.2 dBW
	Data Certus™ 2xC8 16 APSK	18.2 dBW
Modulation	Block 1 Voice/Data	DQPSK
	Certus™ C1, C8 Voice/Data	QPSK
	Certus™ C8 APSK Data	16 APSK
Antenna	Type	Electronically steered phased array
	Polarization	RHCP
	Gain	9.5 dBi
	Beam Width	31° typical per beam
	MissionLINK™ coverage	8° to 90 elevation
Power		
DC Input 10-32 VDC	Voltage	10-32 VDC
	Max Current	12 Amps (10V) – 3.75 Amps (32V)
	Max Power	120 Watts
DC Input 12 VDC	Voltage	12 VDC (+10%/-5%)
	Max Current	10 Amps
	Max Power	120 Watts
Ethernet	3x PoE	PSE Class 2 (6.5 Watts each)
Environmental		
Antenna	IP Rating	IP66
Terminal Unit	IP Rating	IP31

TEMPERATURE

Table 4-2 Operating and Storage Temperatures

Description		Temperature Range
Broadband Active Antenna	Operating Temp	-30°C to +55°C
	Storage Temperature	-40°C to +85°C
Terminal Unit	Operating Temp	-30°C to +55°C
	Storage Temperature	-40°C to +85°C

PHYSICAL CHARACTERISTICS

Table 4-3 Physical Characteristics

Description		Parameters
Broadband Active Antenna	Dimensions	14" D x 4" H (35.6 cm x 10.2 cm)
	Weight	7 lbs (3.2 kg)
Terminal Unit	Dimensions	12" L x 9" W x 3" H (30.5 cm x 23 cm x 7.6 cm)
	Weight	< 7.5 lbs (3.4 kg)

CONNECTOR DETAILS

Connector Location

The DB-15 connector with Pin out shown in Figure 4-1.

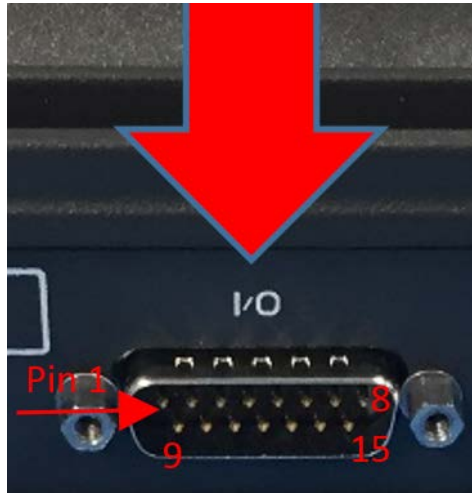

Figure 4-1 GPIO Connector Pin Detail

Table 4-4 GPIO Connector Pin Definition

Pin No	Name	Description
1	GND1	Ground
2	Audio_In +	Radio Gateway functionality, differential (+) Hi-Z Audio Input from external Radio
3	Audio_Out +	Radio Gateway functionality, Differential (+) Low-Z Audio Output to external radio (mic input)
4	RadioCOR	Radio Gateway functionality, Radio initiated voice into terminal (optional)
5	SOS_IN	SOS remote functionality, Ground pin to activate internal SOS
6	GPI01	Software configurable GPIO pin #1 (future)
7	RS232_TD	RS232 Output (future)
8	GND2	Ground
9	Audio_In -	Radio Gateway functionality, differential (-) Hi-Z Audio Input from external Radio
10	Audio_Out -	Radio Gateway functionality, Differential (-) Low-Z Audio Output to external radio (mic input)
11	RadioPTT	Radio Gateway functionality, Putput PTT from terminal to external radio, short to ground for PTT enabled, Open drain requires external 10k pullup resistor
12	GND3	Ground
13	GPI02	Software configurable GPIO pin #2 (future)
14	RS232_RD	RS232 Input (future)
15	12V	+12V output, 100mA

TU 12V Connection Detail

Type: KPPX-4x connector (or similar) shown in Figure 4-2.

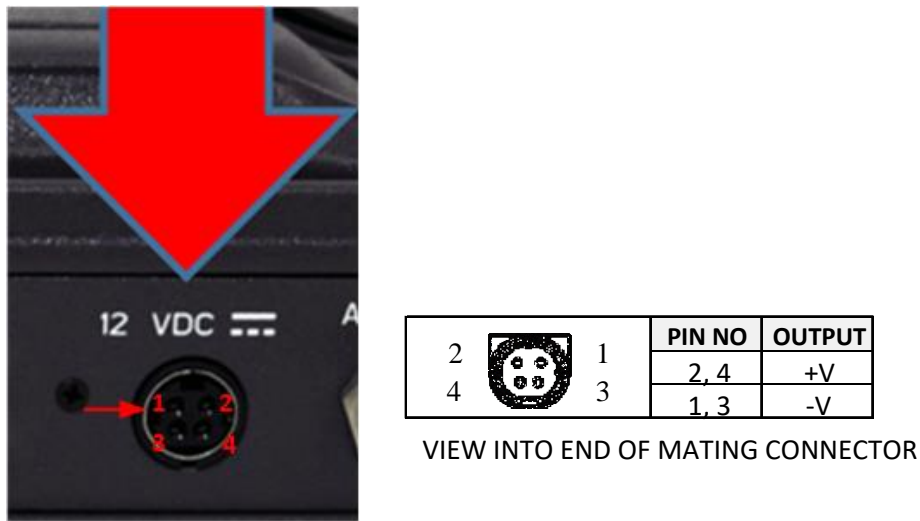

Figure 4-2 12V Input and Mating Connector Detail

TU 10-32VDC Connection Detail

Type: 684M7W2103L201 connector (or similar) shown in Figure 4-3.

A1 = V+ /10-32VDC

A2 =V- /GND

Pin 5 = Ignition

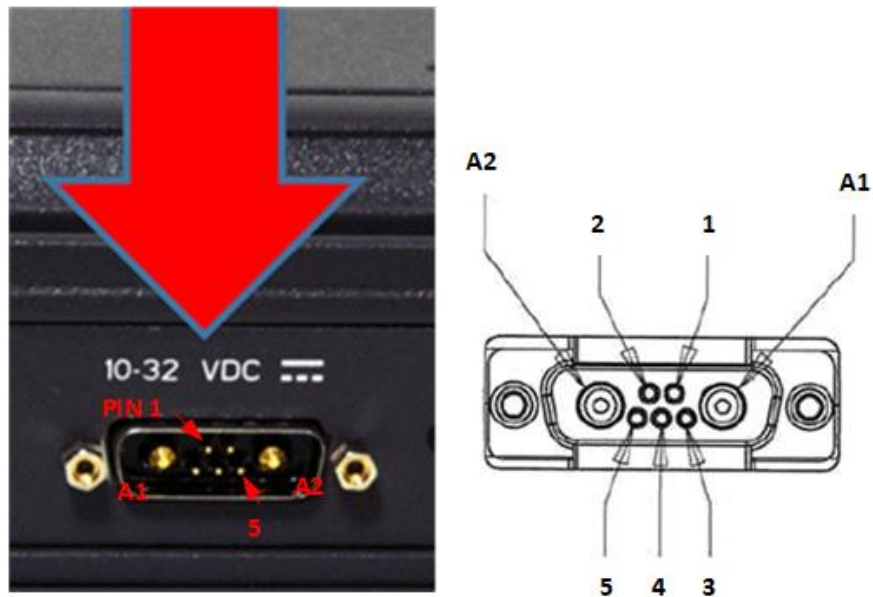

Figure 4-3 10-32 VDC and Mating Connector Detail

CHAPTER 5 ACRONYMS / GLOSSARY

ACRONYMS / GLOSSARY

Table 5-1 List of Acronyms

Acronym	Description
AC	Alternating Current
API	Application Programming Interface
BAA	Broadband Active Antenna
BAE	Broadband Application Electronics
BCX	Broadband Core Transceiver
BIT	Built In Test
dB	Decibel
DC	Direct Current
DHCP	Dynamic Host Configuration Protocol
DTMF	Dual Tone Multi-Frequency
EBB	Enhanced Broadband
ETSI	European Telecommunications Standards Institute
GND	Ground
GPIO	General Purpose Inputs/Outputs
GPS	Global Positioning System
HGA	High Gain Antenna
HRLP	High Speed Radio Link Protocol
HTTP	Hypertext Transfer Protocol
Hz	Hertz
ICMP	Internet Control Message Protocol
IP	Internet Protocol
ITU	International Telecommunications Union
KHz	Kilohertz
LAN	Local Area Network
LED	Light Emitting Diode
LEO	Low Earth Orbiting
LGA	Low Gain Antenna
LOS	Line of Site
MHz	Megahertz
MO	Mobile Originated
MT	Mobile Terminated
NAS	Network Attached Storage
P/N OR PN	Part Number
PBX	Private Branch Exchange
PCM	Pulse Code Modulation
PoE	Power Over Ethernet
POST	Power On Self-Test
POTS	Plain Old Telephone Service

Acronym	Description
PSTN	Public Switched Telephone Network
PWR	Power
QSG	Quick Start Guide
QTY	Quantity
R/W	Read/Write
RF	Radio Frequency
SBC	Smart Battery Charger
SIM	Subscriber Identity Module
SIP	Session Initiation Protocol
SMBus	System Management Bus
SV	Satellite Vehicle
TCP	Transmission Control Protocol
TDSI	Thales Defense & Security, Inc.
TLS	Transport Layer Security
TU	Terminal Unit
UDP	User Datagram Protocol
UL/DL	Uplink/Downlink
VLAN	Virtual Local Area Network
VOIP	Voice of Internet Protocol
WAN	Wide Area Network
Wi-Fi	Wireless Network
WPA2-PSK	Wi-Fi Protected Access 2 – Pre-Shared Key

Table 5-2 List of Definitions

Acronym	Description	
API	Application Programming Interface	The Management Portal provides API to allow for the connection to the terminal remotely.
BAA	Broadband Active Antenna	The antenna and supporting electronics that interface an Iridium satellite terminal with the Iridium constellation
BAE	Broadband Application Electronics	Hardware and software platform resident in the TU that interfaces with the BCX, BAA and user devices
BCX	Broadband Core Transceiver	Hardware designed for an Iridium satellite terminal to interface end-user equipment with an Iridium BAA
BIT	Built In Test	Diagnostic testing for system integrity check and error reporting
DHCP	Dynamic Host Configuration Protocol	The Dynamic Host Configuration Protocol (DHCP) is a system used in computer networking to automatically assign networking information to a client.
DTMF	Dual Tone Multi-Frequency	Signals generated from phone keypad
EBB	Enhanced Broadband	EBB Mode is Iridium NEXT phase 1 EBBS (Enhanced Broadband Service)

Acronym	Description	
ETSI	European Telecommunications Standards Institute	Organization that maintains standards for Information and Communications applicable to fixed and mobile radio platforms
GPIO	General Purpose Inputs/Outputs	General use pins
HGA	High Gain Antenna	External antenna that connects to the TU via a coaxial cable. The HGA2 (also called BAA-H2) provides 352 kbps uplink and downlink capability
HRLP	High Speed Radio Link Protocol	Management of In-band signaling on broadband channels
HTTP	Hypertext Transfer Protocol	Protocol to exchange or transfer hypertext
ICMP	Internet Control Message Protocol	Protocol by network devices that typically send error messages and is used for diagnostics
ITU	International Telecommunications Union	Agency of the United Nations responsible for issues concerning information and communications technologies
LED	Light Emitting Diode	Semiconductor that emits colored light
LGA	Low Gain Antenna	External antenna that connects to the TU via a coaxial cable. The LGA1 and LGA2 support the future Certus™ 100 and Certus™ 200 capabilities
Management Portal		Management Portal: A web page served from the Terminal Unit that brings together the diverse status and configuration information of the TU in one place.
MO	Mobile Originated	Calls originating from the terminal
MT	Mobile Terminated	Calls terminating at the terminal
NAS	Network Attached Storage	Ability to store and retrieve files to/from a physical memory storage device attached to the network
PBX	Private Branch Exchange	Telephone connection between local users not requiring external phone connection
POST	Power On Self-Test	BIT Test performed at the turn-on of the TU
POTS	Plain Old Telephone Service	A voice-grade telephone service that utilizes analog signal transmission over copper loops
PSTN	Public Switched Telephone Network	The world's collection of interconnected voice-orientable public telephone networks, both commercial and government owned.
R/W	Read/Write	Capability
SIM	Subscriber Identification Module	Iridium provided method to authenticate and identify subscriber
SIP	Session Initiation Protocol	An Internet Engineering Task Force (IETF) standard protocol for initiating an interactive user session that involves multimedia elements such as video, voice, and chat
SMBus	System Management Bus	Two-wire bus for communications between devices such as a Terminal and a Smart Battery
SV	Satellite Vehicle	Iridium Satellite
TCP	Transmission Control Protocol	Core internet protocol that provides reliable delivery and error-checking

Acronym	Description	
TLS	Transport Layer Security	TLS is on the standard way that computers on the internet transmit information over an encrypted channel.
TU	Terminal Unit	Electronic equipment that contains the BCX and the BAE
UDP	User Datagram Protocol	Connectionless transmission model with minimum , no-handshaking protocol
UL/DL	Uplink/Downlink	To and from satellite communications
VLAN	Virtual Local Area Network	For context within this document, VLAN more specifically designates an Ethernet VLAN. A VLAN is establishes a broadcast domain that is partitioned
WPA2-PSK	Wi-Fi Protected Access 2 – Pre-Shared Key	Method of securing a Wi-Fi network

INDEX

A	
Acronyms / Glossary.....	5-1
C	
Connector Details.....	4-3
E	
Equipment Overview	
Broadband Active Antenna.....	1-5
Terminal Unit.....	1-2
I	
Installation	
BAA Hard Mounting Detail.....	2-5
BAA Magnetic Mounting Detail	2-3
Connecting Power to the Terminal Unit	2-10
General Guidelines.....	2-1
Installation.....	2-2
Installing the Terminal Unit.....	2-7
Mounting the Broadband Active Antenna	2-2
Precautions During Installation.....	2-1
Preparation	2-1
System Status Indicators	2-13
Introduction	
Equipment Overview	1-1
M	
MissionLINK™ Kit Contents	1-6
T	
Technical Specification	
Physical Characteristics	4-2
Technical Specifications	4-1
Temperature	4-2
Tools and Supplies Needed for Installation	1-8
Troubleshooting	3-1

THIS PAGE INTENTIONALLY LEFT BLANK

NOTES: UNLESS OTHERWISE SPECIFIED.

1. INTERPRET DRAWING PER ASME Y14.100-2013.

2. INTERPRET DIMENSIONS AND TOLERANCES PER ASME Y14.5-2009.

3. IMPLEMENT APPROPRIATE HOLE OR HARDWARE PREPARATION AT INDICATED POSITIONS FOR CHOSEN MOUNTING HARDWARE, THROUGH HOLE DIMENSION SHOWN IS SUGGESTED FOR SUPPLIED M6 HARDWARE.

4. IF THIS DOCUMENT IS PRINTED OR REPRODUCED, USER MUST VERIFY SCALE THROUGH MEASUREMENT OF X AND Y AXES ON SCALE CHECK PROVIDED.

5. IF MOUNTING ANTENNA TO A FLAT SURFACE, ENSURE THAT A CLEARANCE HOLE EXISTS WHERE SHOWN AS BREATHER VENT KEEPOUT, OR THAT SPACERS ARE USED.

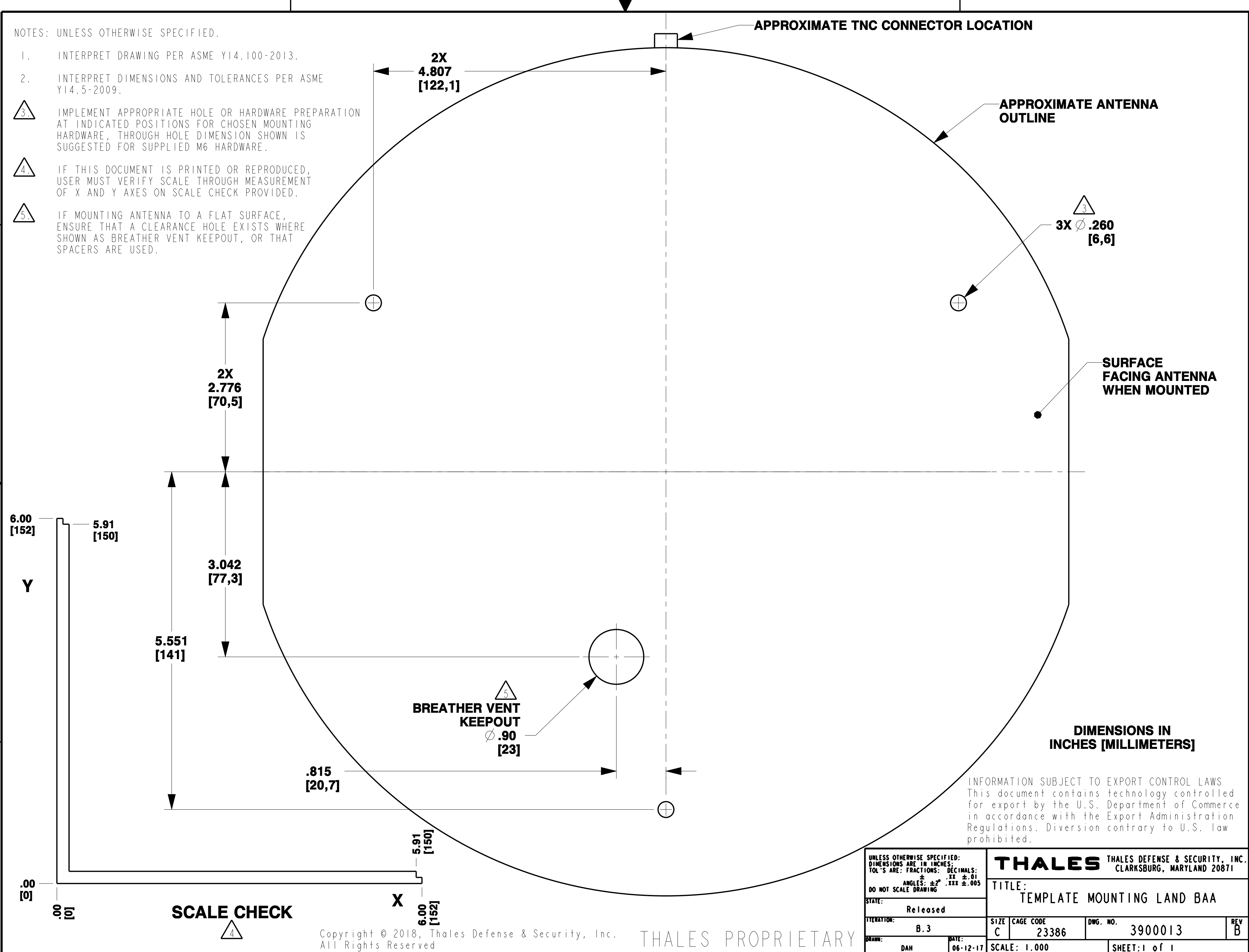

APPROXIMATE TNC CONNECTOR LOCATION

APPROXIMATE ANTENNA OUTLINE

3X ϕ .260 [6,6]

SURFACE FACING ANTENNA WHEN MOUNTED

BREATHER VENT KEEPOUT ϕ .90 [23]

DIMENSIONS IN INCHES [MILLIMETERS]

INFORMATION SUBJECT TO EXPORT CONTROL LAWS
This document contains technology controlled for export by the U.S. Department of Commerce in accordance with the Export Administration Regulations. Diversion contrary to U.S. law prohibited.

SCALE CHECK

Copyright © 2018, Thales Defense & Security, Inc. All Rights Reserved

THALES PROPRIETARY

UNLESS OTHERWISE SPECIFIED: DIMENSIONS ARE IN INCHES: TOL'S ARE: FRACTIONS: DECIMALS: DO NOT SCALE DRAWING	
STATE:	Released
ITERATION:	B.3
DRAWN:	DAH
DATE:	06-12-17

THALES THALES DEFENSE & SECURITY, INC. CLARKSBURG, MARYLAND 20871			
TITLE: TEMPLATE MOUNTING LAND BAA			
SIZE	CAGE CODE	DWG. NO.	REV
C	23386	3900013	B
SCALE: 1.000		SHEET: 1 of 1	

NOTES: UNLESS OTHERWISE SPECIFIED.

1. INTERPRET DRAWING PER ASME Y14.100-2013.
2. INTERPRET DIMENSIONS AND TOLERANCES PER ASME Y14.5-2009.
3. OVERLAY THIS TEMPLATE ON INTENDED MOUNTING SURFACE
4. DETERMINE DESIRED POSITION OF MOUNTING FASTENER IN EACH OF THE FOUR CORNERS WITHIN BOUNDARY OF MOUNTING SLOT. CENTER MARKS (+) WITHIN EACH SLOT DEPICT ONE CENTER POSITION AND THE LIMITS FROM SIDE TO SIDE WHICH MAY BE USED AS FASTENER POSITIONS.
5. PREPARE HOLES APPROPRIATE FOR CHOSEN MOUNTING METHOD OR HARDWARE. 6.6MM THROUGH HOLES RECOMMENDED IF SUPPLIED HARDWARE IS USED.
6. IF THIS DOCUMENT IS PRINTED OR REPRODUCED, USER MUST VERIFY SCALE THROUGH MEASUREMENT OF X AND Y AXES ON SCALE CHECK PROVIDED.

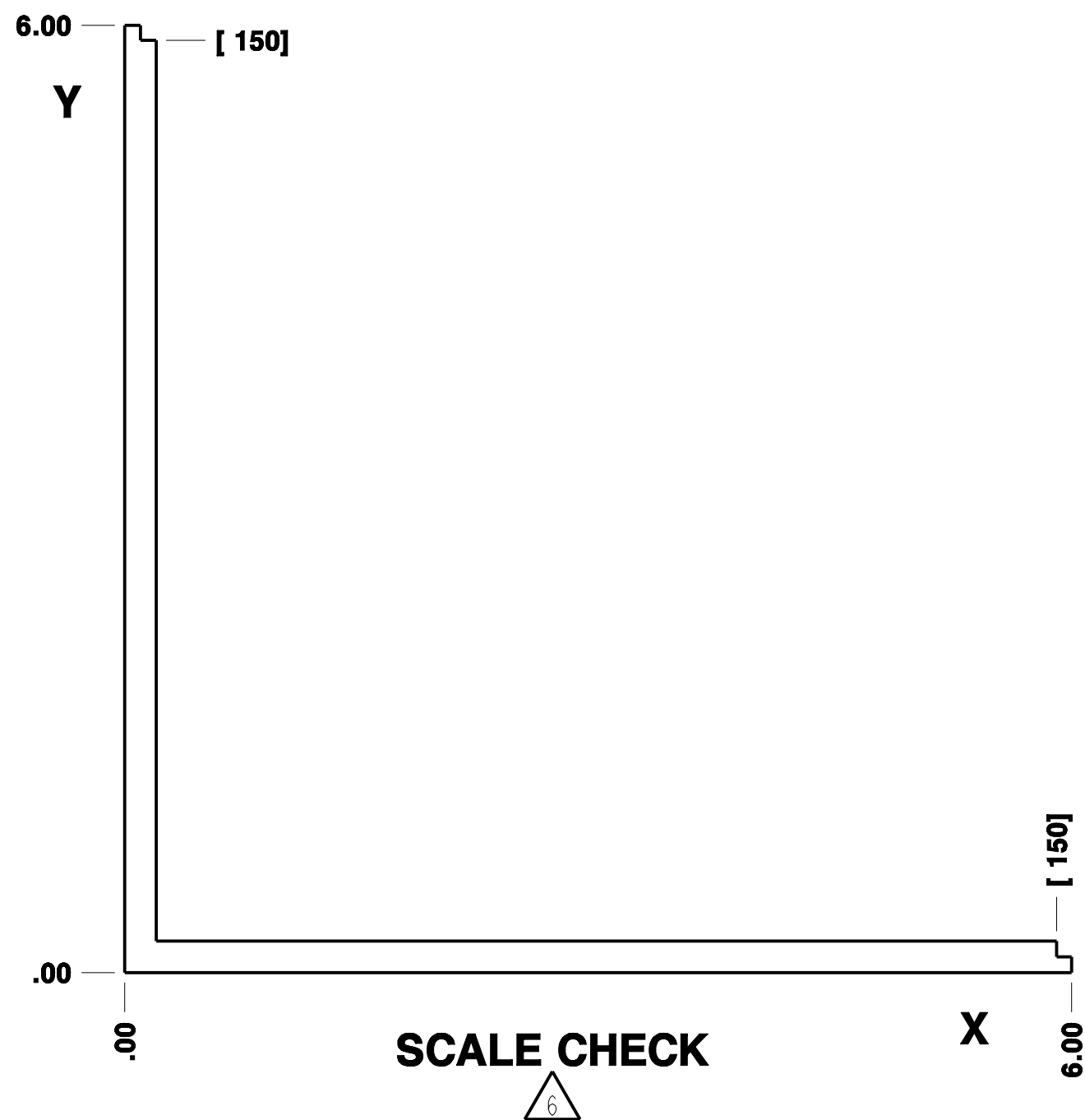

4
4X
CENTER AND LIMIT HOLE LOCATIONS

APPROXIMATE OUTLINE OF TERMINAL UNIT BASE

DIMENSIONS IN INCHES [MILLIMETERS]

INFORMATION SUBJECT TO EXPORT CONTROL LAWS
This document contains technology controlled for export by the U.S. Department of Commerce in accordance with the Export Administration Regulations. Diversion contrary to U.S. law prohibited.

Copyright © 2018, Thales Defense & Security, Inc.
All Rights Reserved

THALES PROPRIETARY

UNLESS OTHERWISE SPECIFIED: DIMENSIONS ARE IN INCHES: TOL'S ARE: FRACTIONS: DECIMALS: ± . XX ±.01 ± . XXX ±.005 DO NOT SCALE DRAWING		THALES THALES DEFENSE & SECURITY, INC. CLARKSBURG, MARYLAND 20871	
STATE: Released		TITLE: TEMPLATE TERMINAL UNIT MOUNT	
ITERATION: B.2	SIZE: C	CAGE CODE: 23386	DWG. NO.: 3900011
DRAWN: DAH	DATE: 05-05-17	SCALE: 1.000	REV: B SHEET: 1 of 1



Thales Defense & Security, Inc.
22605 Gateway Center Drive | Clarksburg MD 20871
Toll-Free 1.800.324.6089 | Phone: 240.864.7000 | Fax: 240.864.7920
Email: Customer.Service@thalesdsi.com | Website: www.thalesdsi.com